

DGP25 - 15.10 - 01P - 11 - 00A (H)

(Series No.) (Pitch) (Poles) (Single Pitch) (Color) :1.(Grey) 2.(Blue) 3.(Black) 4.(Green) 5.(Orange) 6.(Red) 7.(Transparent) 8.(Yellow) 9.(White)

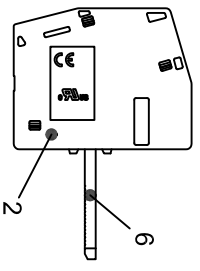

board (1~6mm)

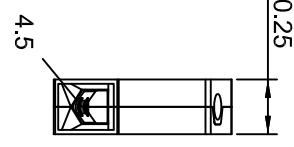
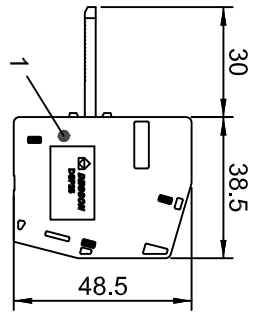
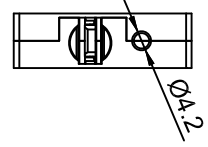
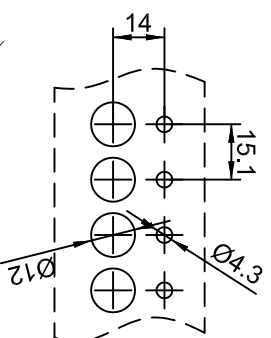

- 1. (Grey)
- 2. (Blue)
- 3. (Black)
- 4. (Green)
- 5. (Orange)
- 6. (Red)
- 7. (Transparent)
- 8. (Yellow)
- 9. (White)

NO.7

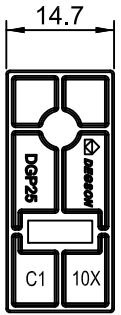
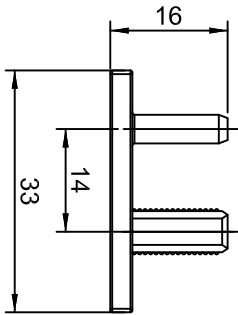

NO.8

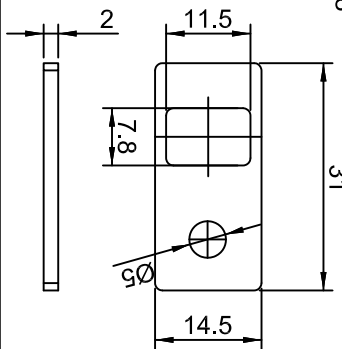

NO.9

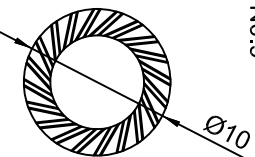

NO.10

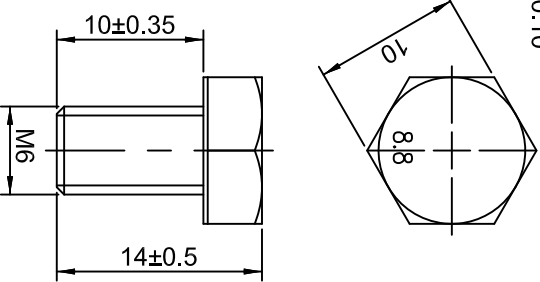

公差表 (General Tolerance)												
单位: mm (inch)												
0	>3	>5	>10	>18	>30	>50	>80	>120	>180	>250	>315	>400
±0.15	±0.18	±0.22	±0.28	±0.35	±0.50	±0.80	±1.00	±1.50	±2.00	±2.50	±3.00	±4.00
5	6	10	18	30	50	80	120	180	250	315	400	500
±0.15	±0.18	±0.22	±0.28	±0.35	±0.50	±0.80	±1.00	±1.50	±2.00	±2.50	±3.00	±4.00
1.7												

ITEM	NAME OF PART	MATERIAL	NOTES
10	Screw2	Steel	M6/Zn plated
9	Lock Washer	Steel	Zn Plated
8	AntiVibration Pad	EVA	Black
7	Housing3	PA66	UL94V-0
6	Current carrier	Copper	Sn plated
5	Steel cage	SPCC	Zn plated
4	Copper cage	Copper Alloy	Ni plated
3	Screw1	Steel	M5/Zn plated
2	Housing2	PA66	UL94V-0
1	Housing1	PA66	UL94V-0

UL 标准/UL Standard:	B	C	D
额定电压/电流/Rated Voltage(V)/Current(A)	600/115	600/115	600/5
EC 标准/IEC Standard:			
过压类别/Overvoltage Category/污染等级	III/3	III/2	II/2
绝缘/Insulation Degree	500/101	/	/
额定电压/电流/Rated Voltage(V)/Current(A)	4	/	/
额定脉冲电压(KV)/Rate Impulse Voltage(KV)	M5.4/0/35.44	/	/
螺丝扭矩/Torque Tightening(N·m/Lb·in)	M6.0/53.16	/	/
使用温度范围/Operating temperature(°C)	-40~+105	/	/
符合RoHS环保要求/Conform to RoHS	Yes	/	/

SURFACE: /

MATERIAL: /

MAT NO.: /

STATUS: /

APPD: /

CHKD: /

DFTI: /

DEGSON 宁波高松电子有限公司
NINGBO DEGSON ELECTRICAL CO., LTD

NAME: DGP25-01P-1Y-00A(H)

DRAWING NO.: 20049183

TYPE: CUSTOMER_DRAWING SCALE: 2:1 SHEET 1/1

REV	ECN	DESCRIPTION	DRT	DATE

1

2

3

4

5

6